

# Data Sheet



Article number: 339703510000

Description: Multibeam 6 Coupling 703.51.0000  
St. steel & clamp hubs

## Measures

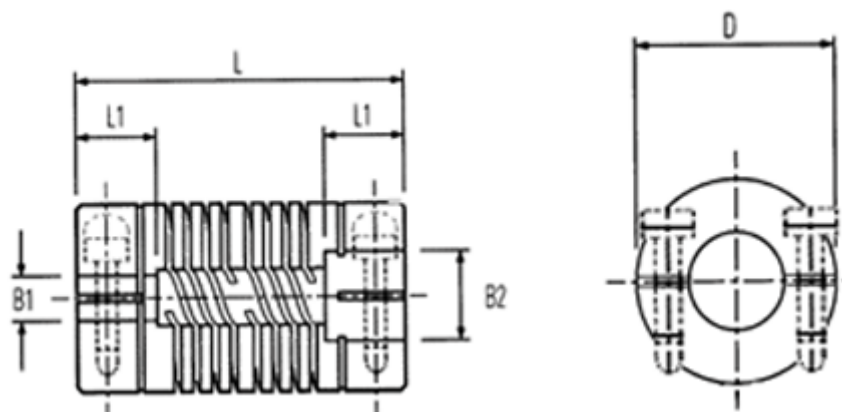

B2: Pre-drilled	= 10.0	Max parallel displacement = 7
B2: Pre-drilled	= 16.00	Peak Torque NM = 73.00
Cap screw	= M6	
D	= 50.8	
L	= 95.3	
L1	= 25.0	
Max angular displacement	= 0.90	
Max B1 & B2	= 26.00	